

## Surface Mount Optocoupler with Phototransistor Output

Order Nos. and Classification table is on sheet 2.

### Description

The MOC series consists of a gallium arsenid infrared-emitting diode, optically coupled to a silicon NPN epitaxial planar transistor in an 8-lead SOIC package (small outline).

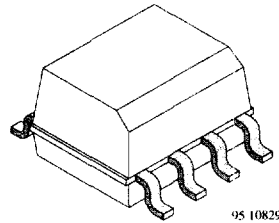

### Applications

- Computer-peripheral interface
- Microprocessor system interface
- Hybride substrates that require high density mounting
- DC/DC converter



### Features

- Current Transfer Ratio (CTR) selected into 3 groups, specified at  $I_F = 10 \text{ mA}$
- MOC205 40 to 80%
- MOC206 63 to 125%
- MOC207 100 to 200%
- Test isolation voltage between input and output  $V_{IO} \text{ (RMS): } 2.5 \text{ kV}$
- 8-lead package, similar SOIC-8
- Minimum  $V_{(BR)CEO}$  of 90 V guaranteed
- Suitable for cleaning process without chemical solvent
- Soldering methods according to CECC 00802 in table 1, class B or C
- Low temperature coefficient of CTR
- Base connected

### Pin Connection

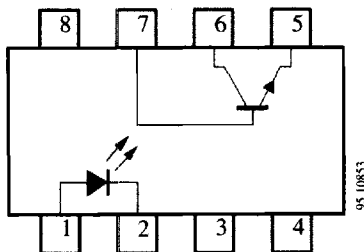

## Order Schematic

Part Numbers	CTR-Ranking
MOC205/ MOC205-GS12	40 to 80%
MOC206/ MOC206-GS12	65 to 125%
MOC207/ MOC207-GS12	100 to 200%

Suffix: GS12 = Taped and reeled version

## Absolute Maximum Ratings

### Input (Emitter)

Parameters	Test Conditions	Symbol	Value	Unit
Reverse voltage		$V_R$	5	V
Forward current		$I_F$	60	mA
Forward surge current	$t_p \leq 10 \mu\text{s}$	$I_{FSM}$	3	A
Power dissipation	$T_{amb} \leq 25^\circ\text{C}$	$P_{tot}$	100	mW
Junction temperature		$T_j$	125	$^\circ\text{C}$

### Output (Detector)

Parameters	Test Conditions	Symbol	Value	Unit
Collector base voltage		$V_{CBO}$	90	V
Collector emitter voltage		$V_{CEO}$	90	V
Emitter collector voltage		$V_{ECO}$	7	V
Collector current		$I_C$	50	mA
Collector peak current	$t_p/T = 0.5, t_p \leq 10 \text{ ms}$	$I_{CM}$	100	mA
Power dissipation	$T_{amb} \leq 25^\circ\text{C}$	$P_{tot}$	150	mW
Junction temperature		$T_j$	125	$^\circ\text{C}$

### Coupler

Parameters	Test Conditions	Symbol	Value	Unit
AC isolation test voltage (RMS)		$V_{IO}^{1)}$	2.5	kV
Total power dissipation	$T_{amb} \leq 25^\circ\text{C}$	$P_{tot}$	250	mW
Ambient temperature range		$T_{amb}$	-55 to +100	$^\circ\text{C}$
Storage temperature range		$T_{stg}$	-55 to +125	$^\circ\text{C}$
Soldering classification	Single wave, $t \leq 10 \text{ s}$	$T_{sd}$	260	$^\circ\text{C}$

1) Related to standard climate 23/50 DIN 50014

## Electrical Characteristics

$T_{amb} = 25^{\circ}\text{C}$

### Input (Emitter)

Parameters	Test Conditions	Type	Symbol	Min.	Typ.	Max.	Unit
Forward voltage	$I_F = 50 \text{ mA}$		$V_F$		1.25	1.6	V
Breakdown voltage	$I_R = 100 \mu\text{A}$		$V_{(BR)}$	5			V
Junction capacitance	$V_R = 0, f = 1 \text{ MHz}$		$C_j$		50		pF

### Output (Detector)

Parameters	Test Conditions	Type	Symbol	Min.	Typ.	Max.	Unit
Collector base breakdown voltage	$I_C = 100 \mu\text{A}$		$V_{(BR)CB0}$	90			V
Collector emitter breakdown voltage	$I_C = 1 \text{ mA}$		$V_{(BR)CEO}$	90			V
Emitter collector breakdown voltage	$I_E = 100 \mu\text{A}$		$V_{(BR)ECO}$	7			V
Collector emitter cut-off current	$V_{CE} = 10 \text{ V}, I_F = 0$		$I_{CEO}$			50	nA

### Coupler

Parameters	Test Conditions	Type	Symbol	Min.	Typ.	Max.	Unit
AC isolation test voltage (RMS)	$f = 50 \text{ Hz}, t = 1 \text{ s}$		$V_{IO}$	2.5			kV
Collector emitter saturation voltage	$I_F = 10 \text{ mA}, I_C = 1 \text{ mA}$		$V_{CEsat}$			0.3	V
Cut-off frequency	$V_{CE} = 5 \text{ V}, I_F = 10 \text{ mA}, R_L = 100 \Omega$		$f_C$		110		kHz
Coupling capacitance	$f = 1 \text{ MHz}$		$C_k$		0.3		pF

### Current Transfer Ratio (CTR)

Parameters	Test Conditions	Type	Symbol	Min.	Typ.	Max.	Unit
$I_C/I_F$	$V_{CE} = 10 \text{ V}, I_F = 10 \text{ mA}$	MOC205	CTR	0.4		0.8	
		MOC206		0.65		1.25	
		MOC207		1		2	

## Switching Characteristics (Typical Values)

$V_S = 10\text{ V}$

Type	$R_L = 100\ \Omega$ (see figure 1)						
	$t_d[\mu\text{s}]$	$t_r[\mu\text{s}]$	$t_{on}[\mu\text{s}]$	$t_f[\mu\text{s}]$	$t_r[\mu\text{s}]$	$t_{off}[\mu\text{s}]$	$I_C[\text{mA}]$
MOC205/MOC205-GS12	0.90	1.10	2.00	0.10	1.80	1.90	2
MOC206/MOC206-GS12	1.60	1.80	3.40	0.10	2.60	2.70	2
MOC207/MOC207-GS12	2.20	2.80	5.00	0.20	4.10	4.30	2

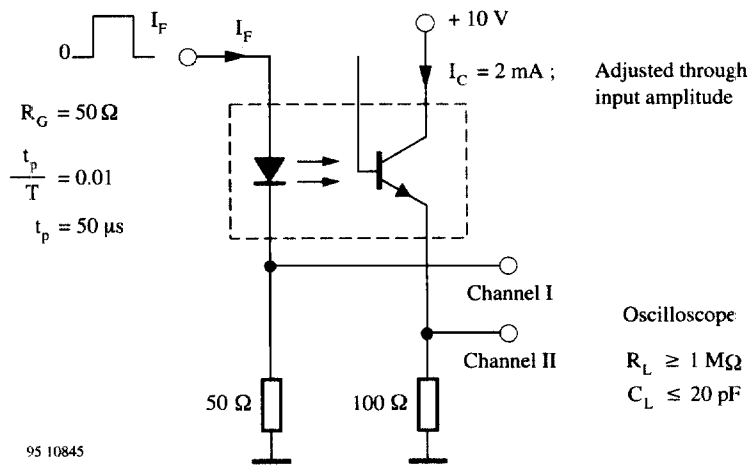

Figure 1. Test circuit, non-saturated operation

**Typical Characteristics** ( $T_{amb} = 25^{\circ}\text{C}$ , unless otherwise specified)

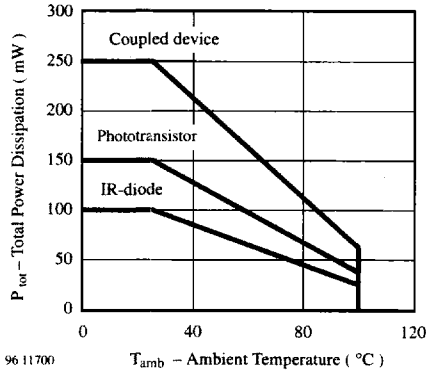

Figure 1. Total Power Dissipation vs. Ambient Temperature

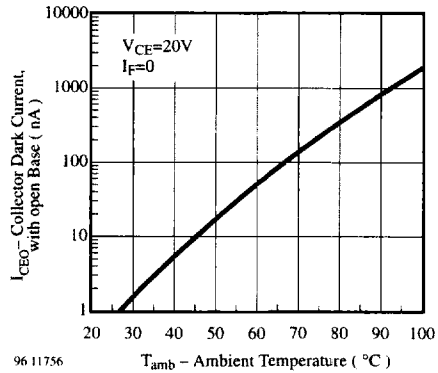

Figure 4. Collector Dark Current vs. Ambient Temperature

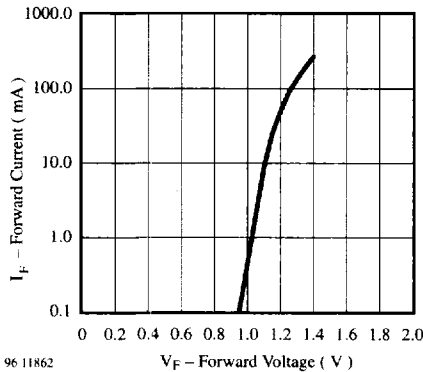

Figure 2. Forward Current vs. Forward Voltage

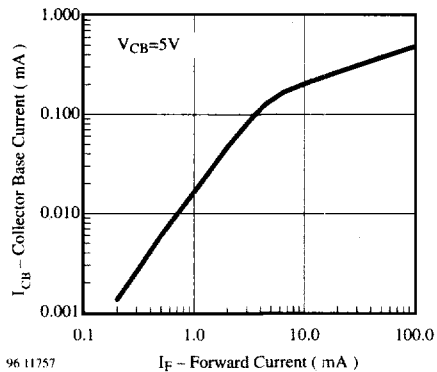

Figure 5. Collector Base Current vs. Forward Current

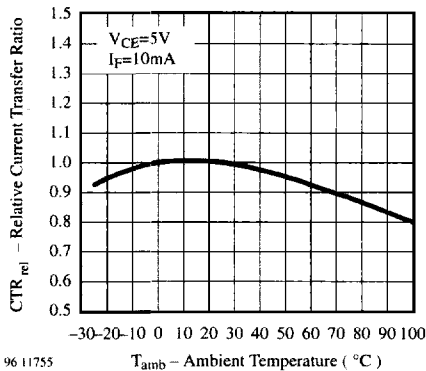

Figure 3. Rel. Current Transfer Ratio vs. Ambient Temp.

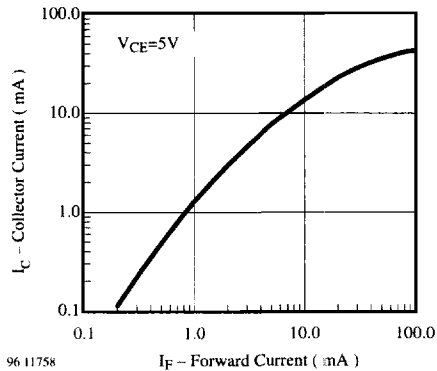

Figure 6. Collector Current vs. Forward Current

## Typical Characteristics ( $T_{amb} = 25^{\circ}\text{C}$ , unless otherwise specified)

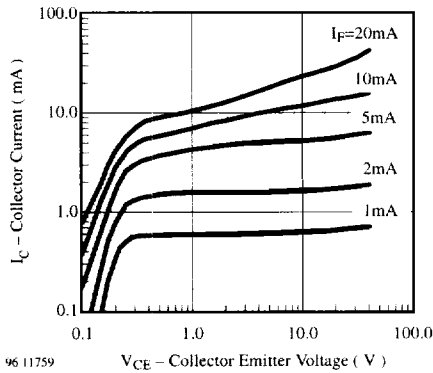

Figure 7. Collector Current vs. Collector Emitter Voltage

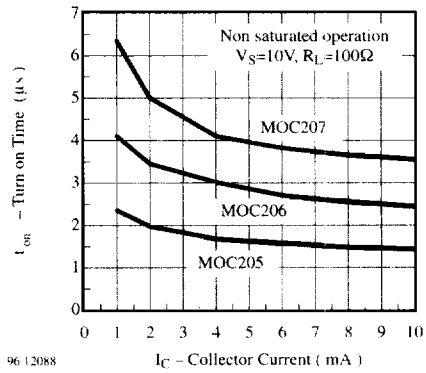

Figure 10. Turn on Time vs. Collector Current

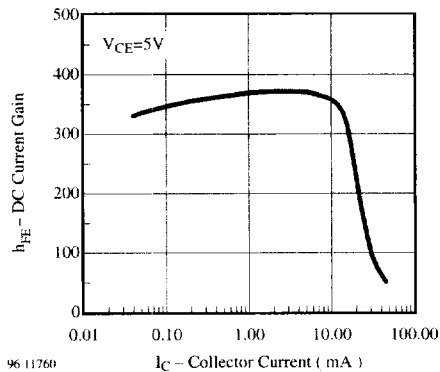

Figure 8. DC Current Gain vs. Collector Current

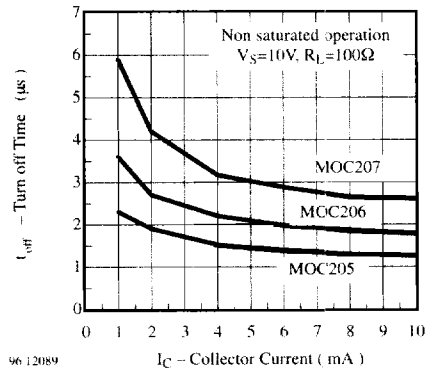

Figure 11. Turn off Time vs. Collector Current

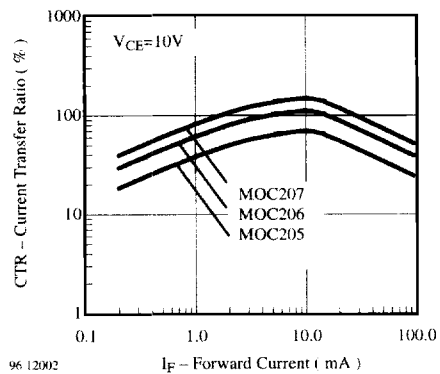

Figure 9. Current Transfer Ratio vs. Forward Current

**Dimensions in mm**

